

Article number: 0102163

Description: Retaining ring J230 DIN472
Spring steel

Measures

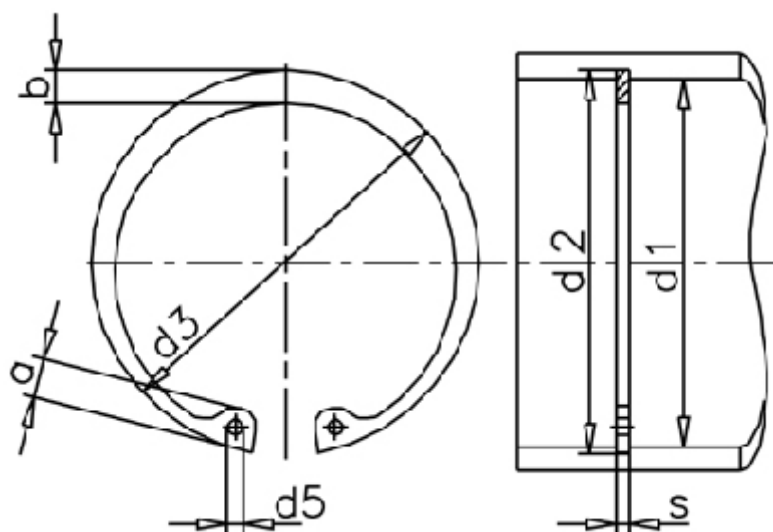

a max	= 14.2	FN kN	= 365.00	t	= 3.00
AN mm ²	= 2196.0	FRg kN	= 81.0	tol	= +0,72
b	= 14.0	FR kN	= 549.0	tol	= +1,70-0,72
d1	= 230	g	= 4.0	tol	= -0.12
d2	= 336.0	K kN-mm	= 1259.0	Tong	= ZGJ-5
d3	= 242.00	m min	= 5.15	Weight kg/1000	= 330.00
d5 min	= 4.0	Nominal drive	= 9.0		
Description = J 230		s	= 5.00		